

102 Greenwich Ave, New York, NY 10011

Block:617 Lot:32

LEDER - LUIS ARCHITECTURAL
DESIGN PLLC
66 MAIN STREET SUITE # 913
YONKERS, NEW YORK 10701
914 423 9778 FAX. 914 423 9781

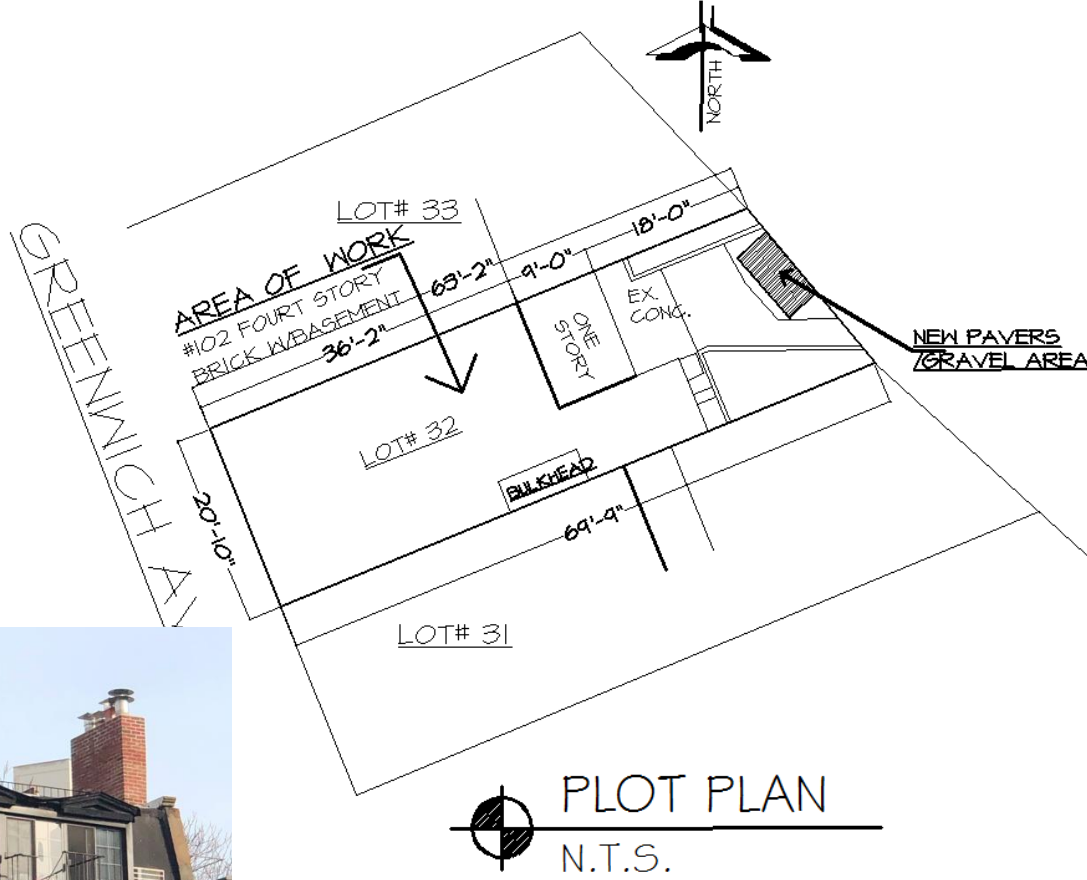

Historical district designation:
Greenwich Village Historic District

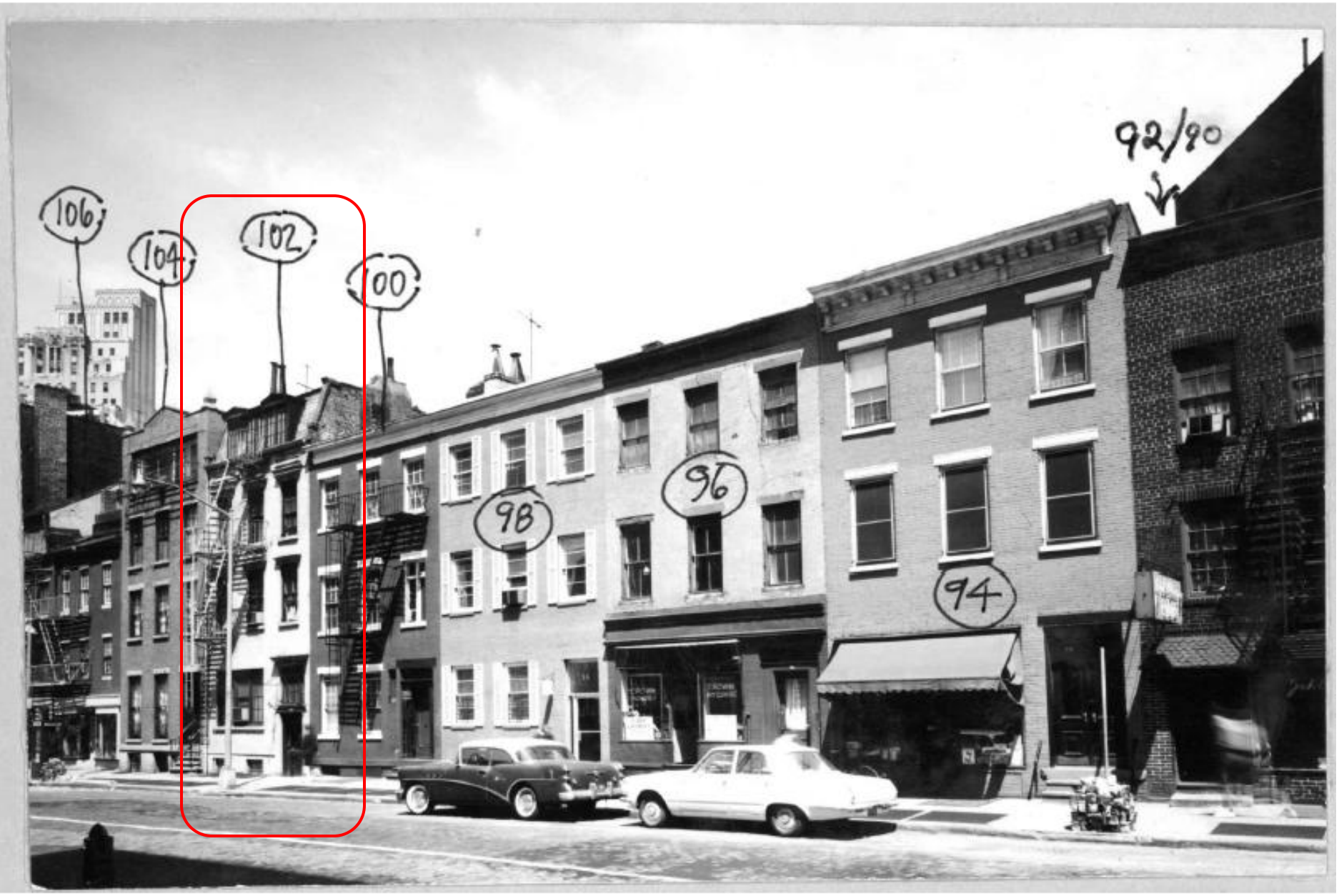



EXPOSURE OF BUILDING LOOKING NORTH
BOUND ON GREENWICH AVENUE



EXPOSURE OF BUILDING LOOKING SOUTH
BOUND ON GREENWICH AVENUE



EXPOSURE OF BUILDING LOOKING FROM JANE ST.
BOUND ON GREENWICH AVENUE



EXISTING BULKHEAD
TO BE LEGALIZE

EXPOSURE OF BUILDING LOOKING NORTH
BOUND ON GREENWICH AVENUE

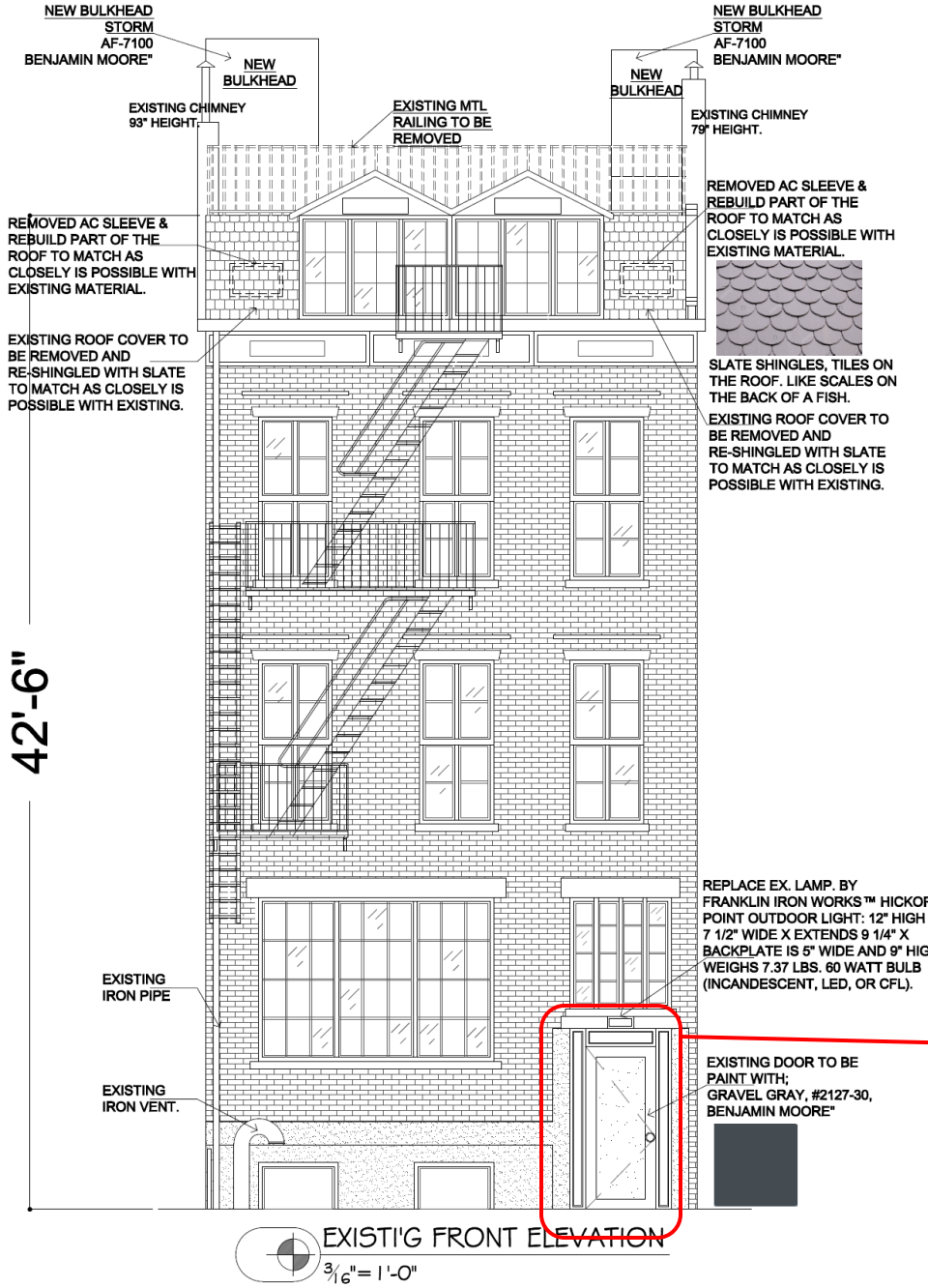

Window are painted 2127-30 Gravel Gray



Gravel Gray
2127-30

Existing door will be painted 2127-30 Gravel Gray to match windows

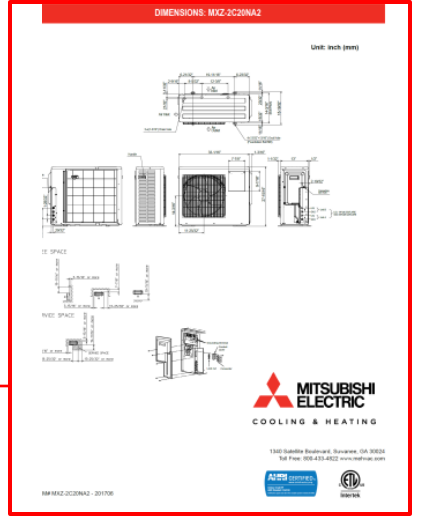
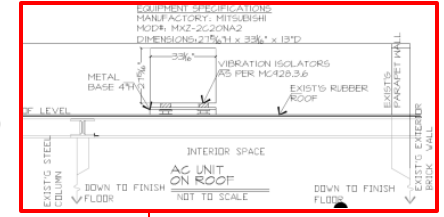
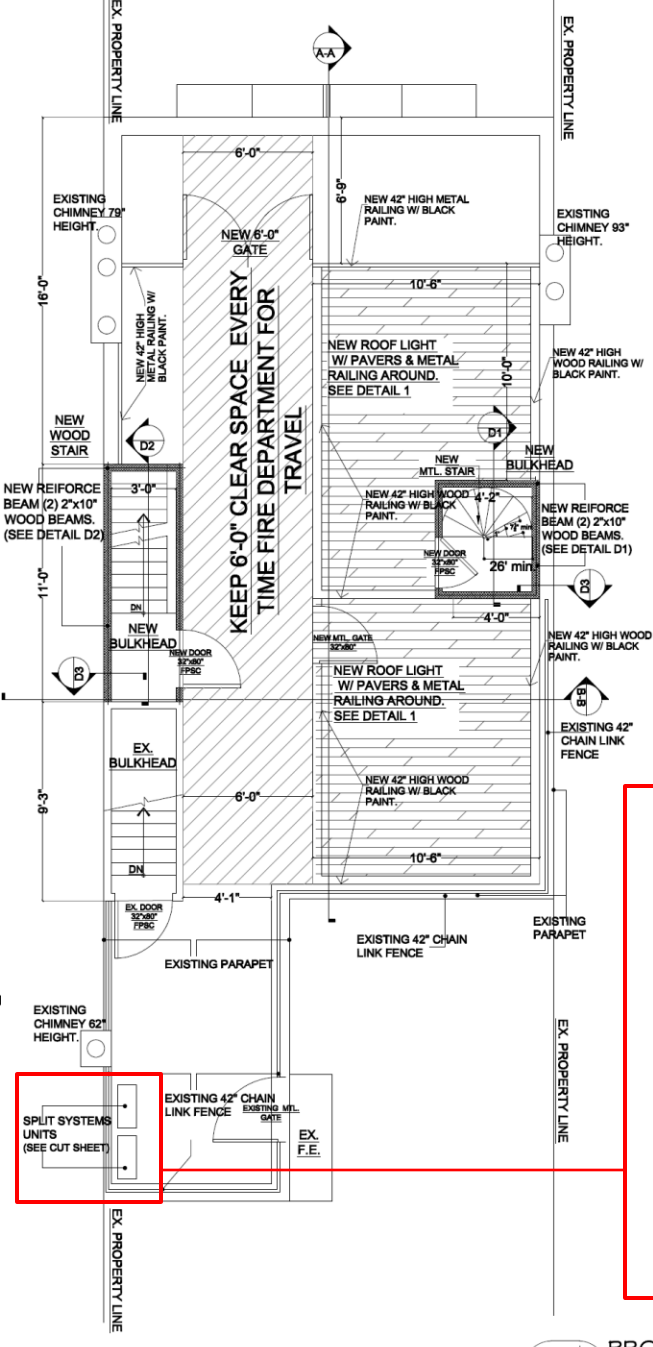
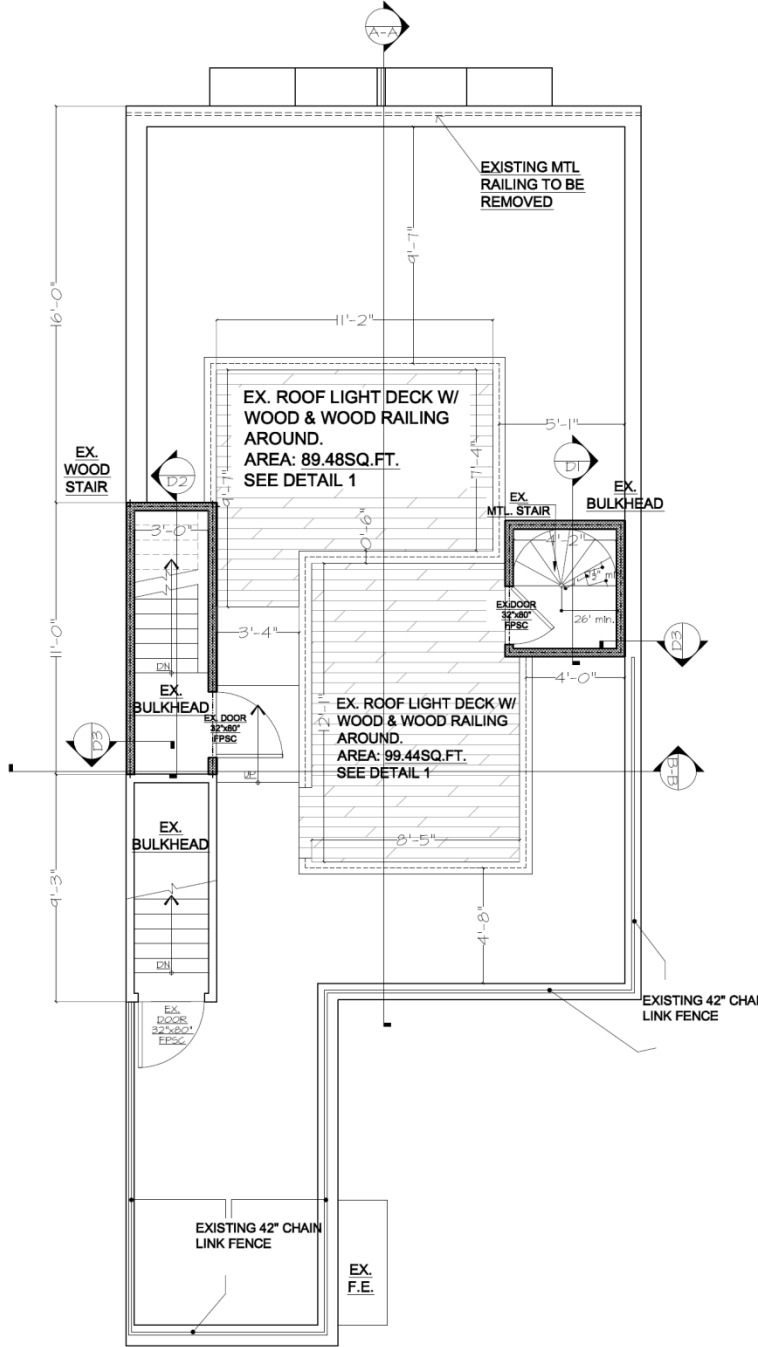

EXISTING ROOF FLOOR PLAN
SCALE: 1/4" = 1'-0"

PROPOSED ROOF FLOOR PLAN
SCALE: 1/4" = 1'-0"

GREENWICH AVENUE

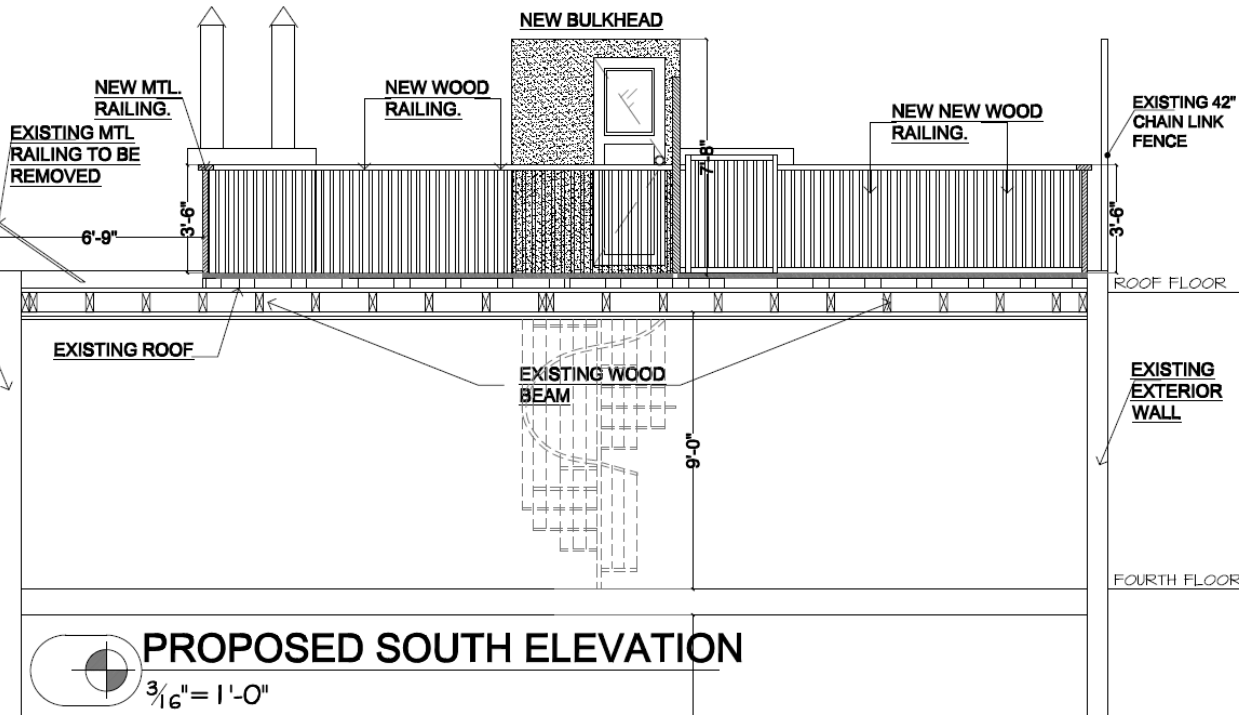

PROPOSED SOUTH ELEVATION

$\frac{3}{16}'' = 1'-0''$

GREENWICH AVENUE

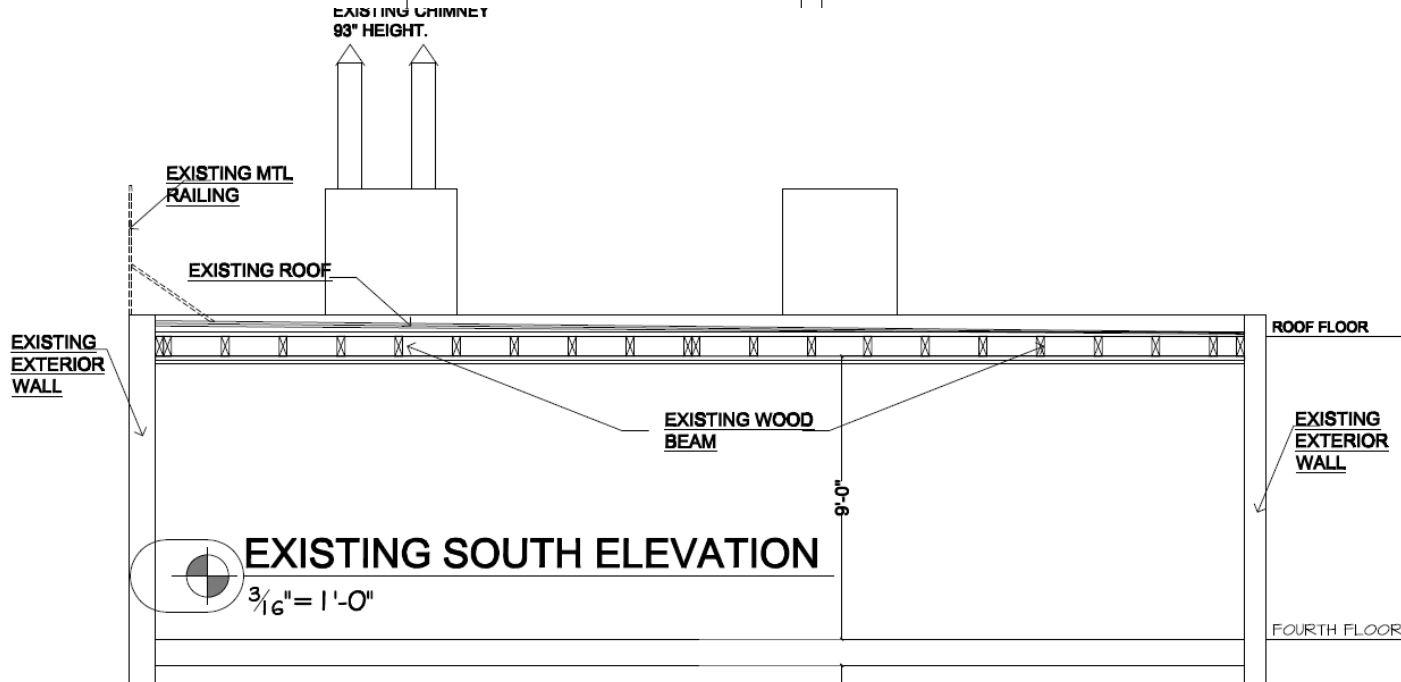

EXISTING SOUTH ELEVATION

$\frac{3}{16}'' = 1'-0''$

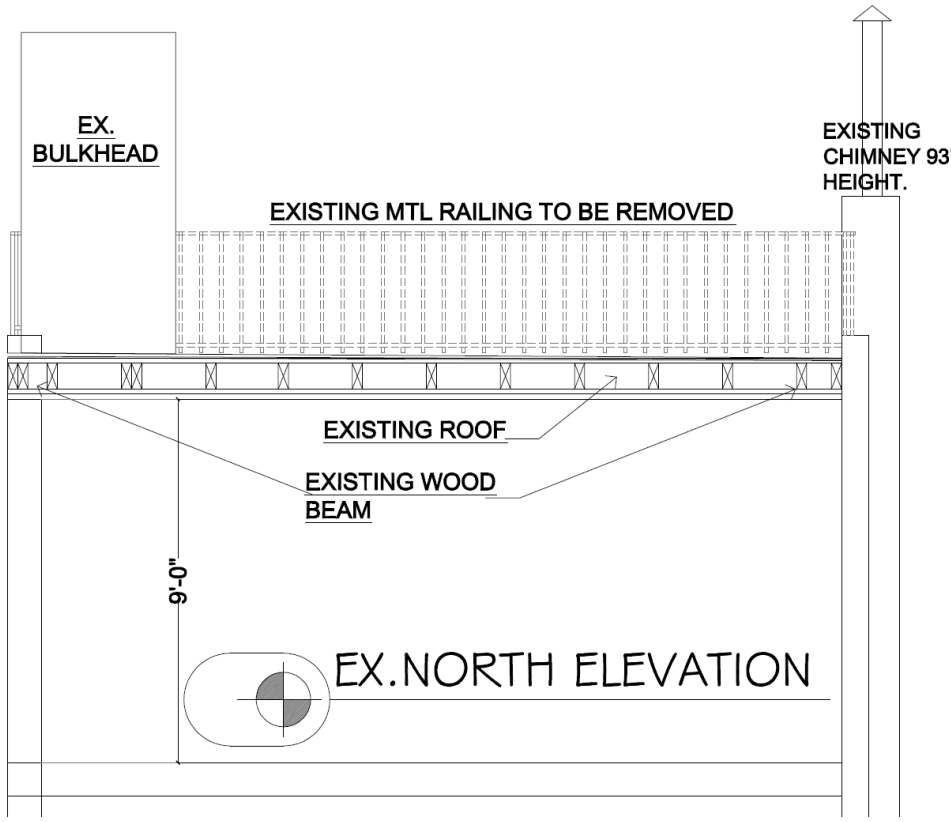
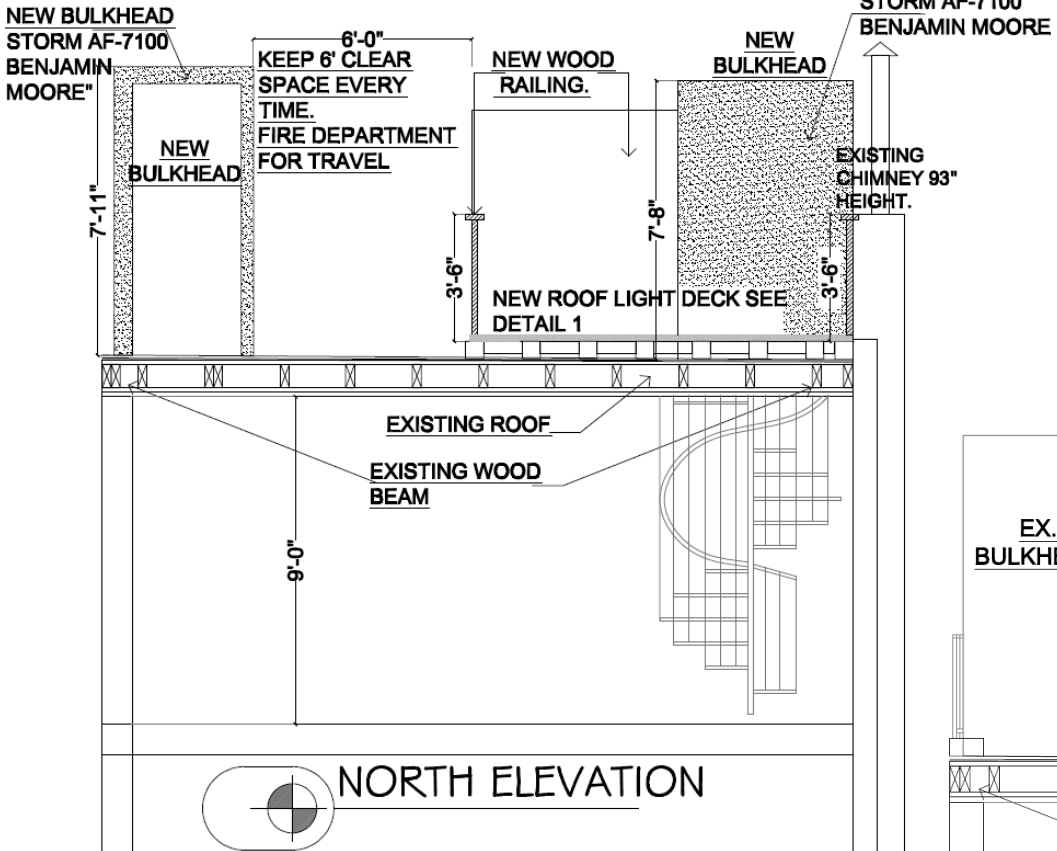

Note: Proposed finish of the bulkhead is stucco painted Benjamin Moore Storm AF-700

Storm AF-700

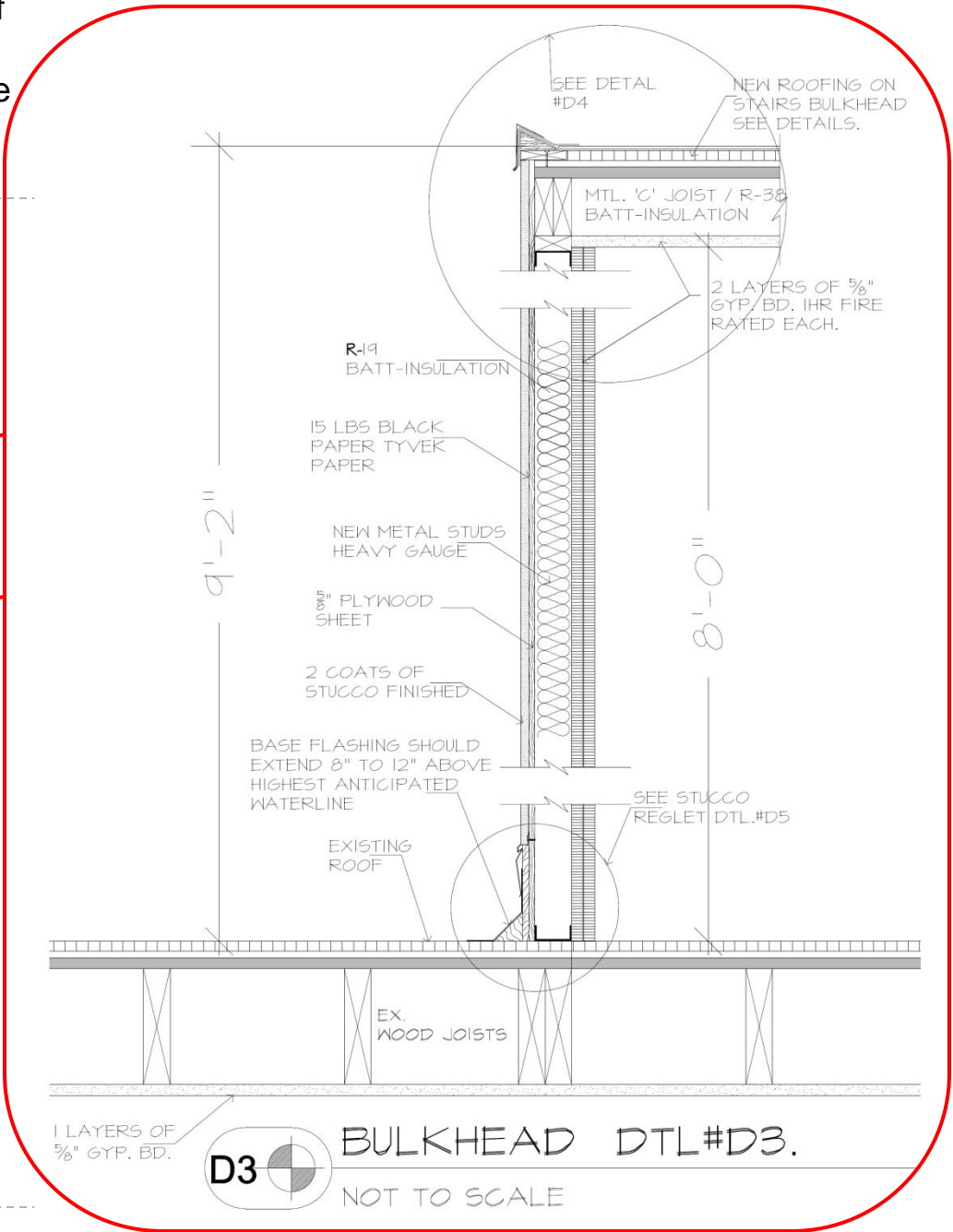
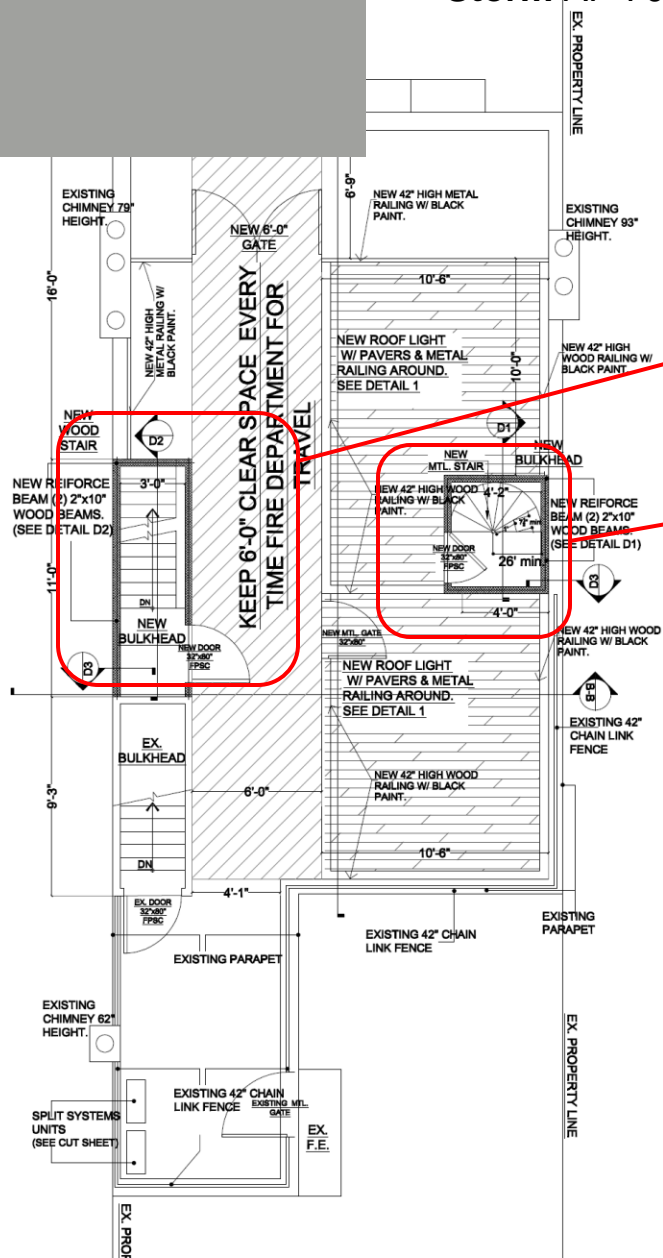

D3 BULKHEAD DTL#D3.
NOT TO SCALE

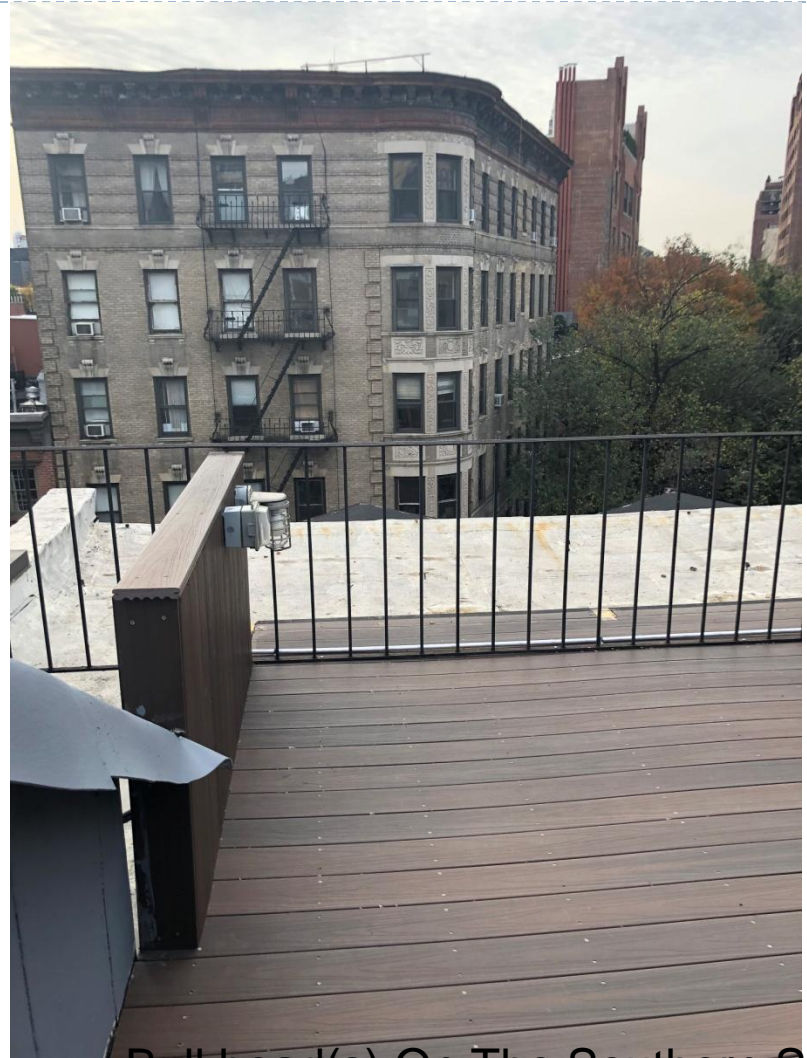

Bulkhead(s) On The Southern Side



Bulkhead(s) On The Southern Side



Bulkhead(s) On The Southern Side



